

BCW32

NPN General Purpose Amplifier

- This device is designed for general purpose applications at collector currents to 300mA.
- Sourced from process 10.

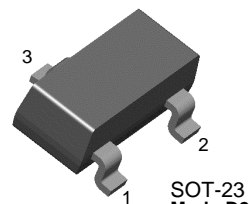

1. Base 2. Emitter 3. Collector

Absolute Maximum Ratings * $T_a=25^\circ\text{C}$ unless otherwise noted

| Symbol | Parameter | Value | Units |
|----------------|--|------------|------------------|
| V_{CEO} | Collector-Emitter Voltage | 32 | V |
| V_{CBO} | Collector-Base Voltage | 32 | V |
| V_{EBO} | Emitter-Base Voltage | 5.0 | V |
| I_C | Collector current (DC) | 500 | mA |
| T_J, T_{stg} | Operating and Storage Junction Temperature Range | -55 ~ +150 | $^\circ\text{C}$ |

* These ratings are limiting values above which the serviceability of any semiconductor device may be impaired.

NOTES:

- These ratings are based on a maximum junction temperature of 150 degrees C.
- These are state limits. The factory should be consulted on applications involving pulsed or low duty cycle operations.

Electrical Characteristics $T_a=25^\circ\text{C}$ unless otherwise noted

| Symbol | Parameter | Test Condition | Min. | Typ. | Max. | Units |
|-------------------------------------|--------------------------------------|--|------|------|-----------|---------------------|
| Off Characteristics | | | | | | |
| $V_{(BR)CBO}$ | Collector-Base Breakdown Voltage | $I_C = 2.0\text{mA}, I_B = 0$ | 32 | | | V |
| $V_{(BR)CEO}$ | Collector-Emitter Breakdown Voltage | $I_C = 10\mu\text{A}, I_B = 0$ | 32 | | | V |
| $V_{(BR)EBO}$ | Emitter-Base Breakdown Voltage | $I_C = 10\mu\text{A}, I_C = 0$ | 5.0 | | | V |
| I_{CBO} | Collector Cutoff Current | $V_{CB} = 32\text{V}, I_E = 0$ $V_{CB} = 32\text{V}, I_E = 0, T_A = 100^\circ\text{C}$ | | | 100 10 | nA μA |
| On Characteristics | | | | | | |
| h_{FE} | DC Current Gain | $I_C = 2.0\text{mA}, V_{CE} = 5.0\text{V}$ | 200 | | 450 | |
| $V_{CE(sat)}$ | Collector-Emitter Saturation Voltage | $I_C = 10\text{mA}, I_B = 0.5\text{mA}$ | | | 0.25 | V |
| $V_{BE(on)}$ | Base-Emitter On Voltage | $I_C = 2.0\text{mA}, V_{CE} = 5.0\text{V}$ | 0.55 | | 0.7 | V |
| Small Signal Characteristics | | | | | | |
| f_T | Current Gain Bandwidth Product | $I_C = 2.0\text{mA}, V_{CE} = 5.0\text{V}$ $f = 35\text{MHz}$ | 200 | | | |
| C_{obo} | Output Capacitance | $V_{CB} = 10\text{V}, I_E = 0, f = 1.0\text{MHz}$ | | | 4.0 | pF |
| NF | Noise Figure | $I_C = 0.2\text{mA}, V_{CE} = 5.0\text{V}$ $R_S = 2.0\text{k}\Omega, f = 1.0\text{kHz}$ $B_W = 200\text{Hz}$ | | | 10 | dB |

Thermal Characteristics $T_a=25^\circ\text{C}$ unless otherwise noted

| Symbol | Parameter | Max. | Units |
|-----------------|---|------------|----------------------------|
| P_D | Total Device Dissipation Derate above 25°C | 350 2.8 | mW mW/ $^\circ\text{C}$ |
| $R_{\theta JA}$ | Thermal Resistance, Junction to Ambient | 357 | $^\circ\text{C}/\text{W}$ |

Device mounted on FR-4PCB 40mm x 40mm x 1.5mm

Typical Characteristics

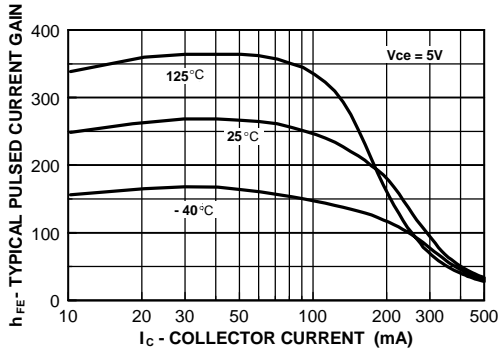

Figure 1. Typical Pulsed Current Gain vs Collector Current

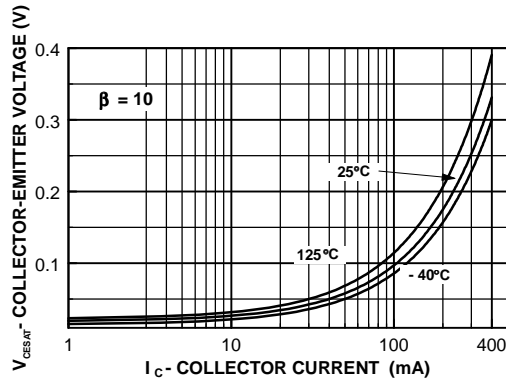

Figure 2. Collector-Emitter Saturation Voltage vs Collector Current

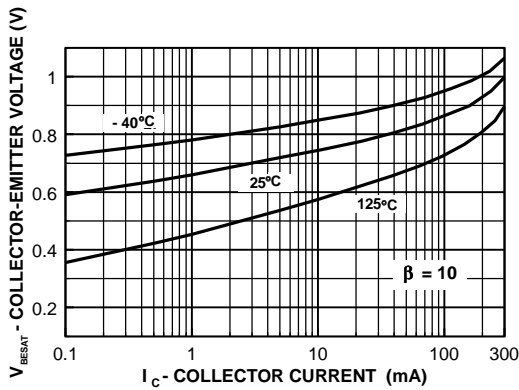

Figure 3. Base-Emitter Saturation Voltage vs Collector Current

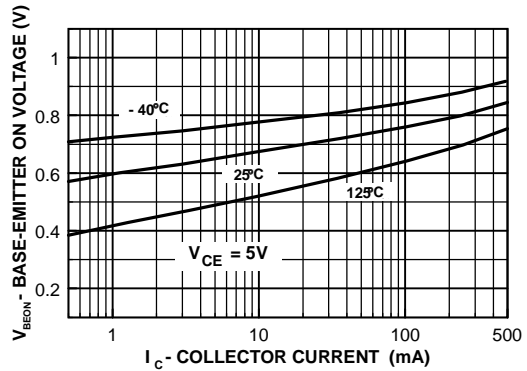

Figure 4. Base-Emitter On Voltage vs Collector Current

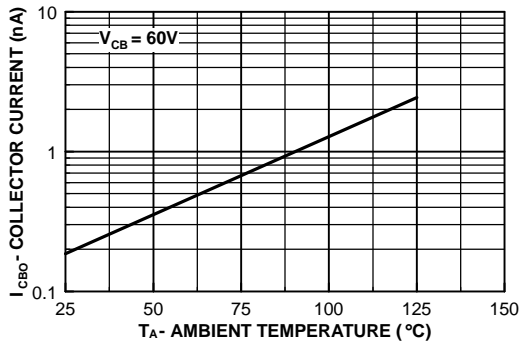

Figure 5. Collector-Cutoff Current vs Ambient Temperature

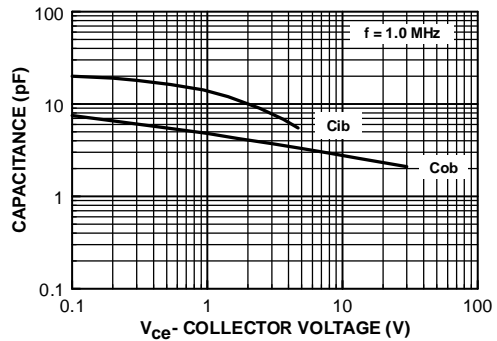

Figure 6. Input and Output Capacitance vs Reverse Voltage

Typical Characteristics (Continued)

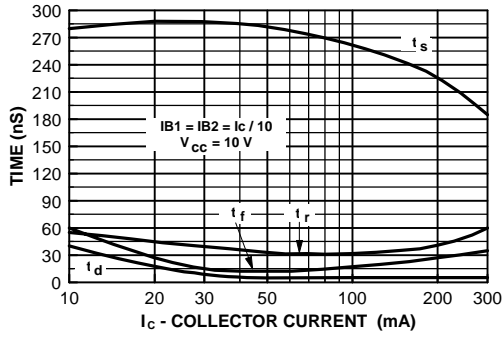

Figure 7. Switching Times vs Collector Current

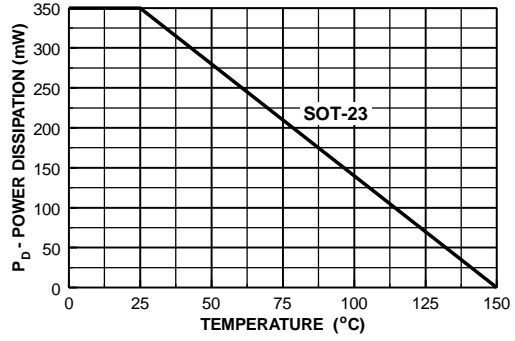
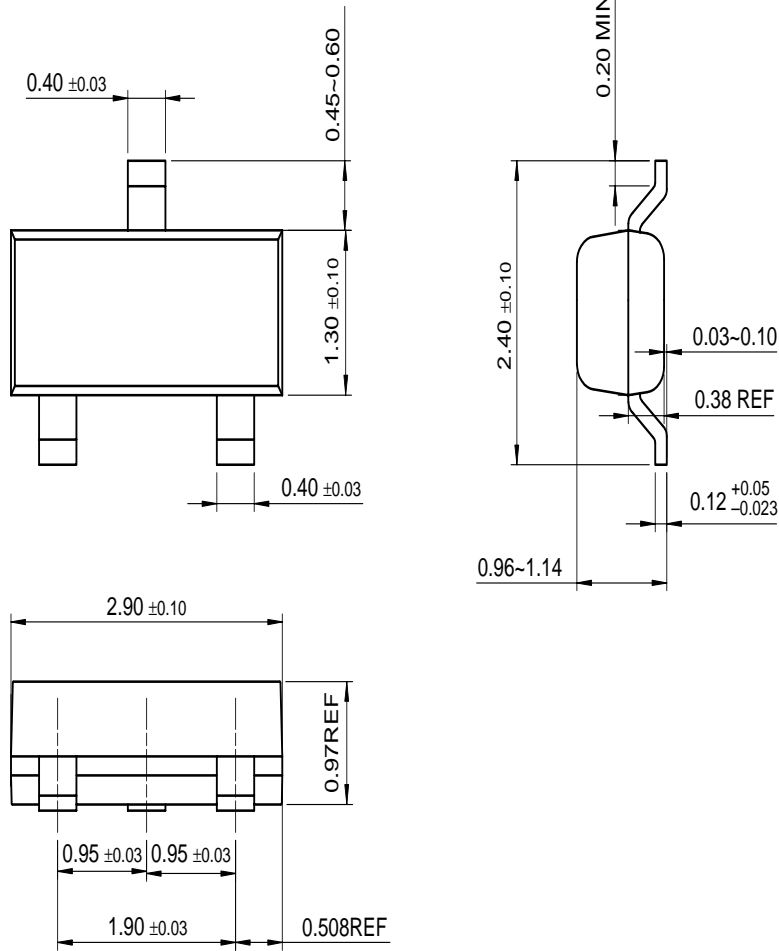

Figure 8. Power Dissipation vs Ambient Temperature

Package Dimensions

SOT-23



Dimensions in Millimeters

TRADEMARKS

The following are registered and unregistered trademarks Fairchild Semiconductor owns or is authorized to use and is not intended to be an exhaustive list of all such trademarks.

| | | | | |
|--|---------------------------------|--------------------------------|---------------------------------|-----------------------------|
| ACE [™] | FACT [™] | ImpliedDisconnect [™] | PACMAN [™] | SPM [™] |
| ActiveArray [™] | FACT Quiet series [™] | ISOPLANAR [™] | POP [™] | Stealth [™] |
| Bottomless [™] | FAST [®] | LittleFET [™] | Power247 [™] | SuperSOT [™] -3 |
| CoolFET [™] | FAST ^r [™] | MicroFET [™] | PowerTrench [®] | SuperSOT [™] -6 |
| CROSSVOLT [™] | FRFET [™] | MicroPak [™] | QFET [™] | SuperSOT [™] -8 |
| DOME [™] | GlobalOptoisolator [™] | MICROWIRE [™] | QS [™] | SyncFET [™] |
| EcoSPARK [™] | GTO [™] | MSX [™] | QT Optoelectronics [™] | TinyLogic [™] |
| E ² CMOS [™] | HiSeC [™] | MSXPro [™] | Quiet Series [™] | TruTranslation [™] |
| EnSigna [™] | I ² C [™] | OCX [™] | RapidConfigure [™] | UHC [™] |
| Across the board. Around the world. [™] | | OCXPro [™] | RapidConnect [™] | UltraFET [®] |
| The Power Franchise [™] | | OPTOLOGIC [®] | SILENT SWITCHER [®] | VCX [™] |
| Programmable Active Droop [™] | | OPTOPLANAR [™] | SMART START [™] | |

DISCLAIMER

FAIRCHILD SEMICONDUCTOR RESERVES THE RIGHT TO MAKE CHANGES WITHOUT FURTHER NOTICE TO ANY PRODUCTS HEREIN TO IMPROVE RELIABILITY, FUNCTION OR DESIGN. FAIRCHILD DOES NOT ASSUME ANY LIABILITY ARISING OUT OF THE APPLICATION OR USE OF ANY PRODUCT OR CIRCUIT DESCRIBED HEREIN; NEITHER DOES IT CONVEY ANY LICENSE UNDER ITS PATENT RIGHTS, NOR THE RIGHTS OF OTHERS.

LIFE SUPPORT POLICY

FAIRCHILD'S PRODUCTS ARE NOT AUTHORIZED FOR USE AS CRITICAL COMPONENTS IN LIFE SUPPORT DEVICES OR SYSTEMS WITHOUT THE EXPRESS WRITTEN APPROVAL OF FAIRCHILD SEMICONDUCTOR CORPORATION.

As used herein:

1. Life support devices or systems are devices or systems which, (a) are intended for surgical implant into the body, or (b) support or sustain life, or (c) whose failure to perform when properly used in accordance with instructions for use provided in the labeling, can be reasonably expected to result in significant injury to the user.
2. A critical component is any component of a life support device or system whose failure to perform can be reasonably expected to cause the failure of the life support device or system, or to affect its safety or effectiveness.

PRODUCT STATUS DEFINITIONS

Definition of Terms

| Datasheet Identification | Product Status | Definition |
|--------------------------|------------------------|---|
| Advance Information | Formative or In Design | This datasheet contains the design specifications for product development. Specifications may change in any manner without notice. |
| Preliminary | First Production | This datasheet contains preliminary data, and supplementary data will be published at a later date. Fairchild Semiconductor reserves the right to make changes at any time without notice in order to improve design. |
| No Identification Needed | Full Production | This datasheet contains final specifications. Fairchild Semiconductor reserves the right to make changes at any time without notice in order to improve design. |
| Obsolete | Not In Production | This datasheet contains specifications on a product that has been discontinued by Fairchild semiconductor. The datasheet is printed for reference information only. |